



PLANNING GUIDE

Systems for Pitched Green Roofs

Life on Roofs



More Options with ZinCo



What Do we Need to Know? 4



Pitched Green Roof with Floraset® 6



Technically Sound Detail Solutions 8



Steep Pitched Green Roof with ZinCo Georaster® 10



Accessories for Steep Pitched Green Roofs
Intensive Green Roof on Pitched Roofs 13



Material Variations on Pitched Roofs
Greening Barrel Roofs 15



Plant Selection 16

Green Oases for our Cityscape

Environmental, urban and engineering benefits of a green roof:

Protection of the Roof Membrane

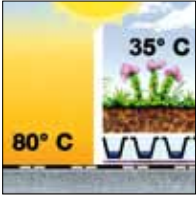

- Protects the roof membrane from UV radiation, heat, cold and hail

New Habitat



- Avoids sealing and creates new habitat for plants and animals

Rainwater Retention

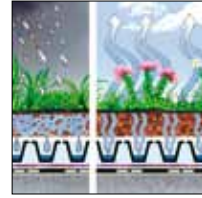

- Reduces run-off

Binds Dust



- Enhances the microclimate by filtering out dust and smog particles

Reduction of Energy Costs

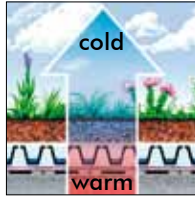

- Thermal protection and reduction in heating and cooling costs

Noise Protection

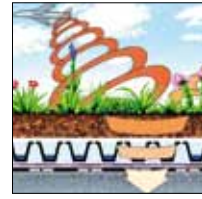

- Enhances sound insulation

Features

- In contrast to flat roofs where roof gardens are often installed, pitched roofs are usually equipped with low maintenance extensive green roofs.
- Shear forces are to be derived into stable eaves edgings and – if necessary – into additional shear barriers using load absorbing elements.
- Due to the faster water runoff on pitched roof areas the substrate layer needs to be increased; the possibility of an additional irrigation should be given.
- To prevent erosion on pitched roofs plants should be applied with a higher density; in case of a steep pitch precultivated vegetation mats are recommended
- On pitched roofs the orientation of the roof area (North / South) might affect vegetation development.

Principles

Green roofs are created and installed by ZinCo in line with prevailing standards and with system.

Our five principles at a glance:

- The System Build-up is adapted to the given roof.
- The choice of plants is selected to suit the extreme location of a pitched or steep pitched roof.
- The System Build-up provides for a good balance of moisture and air.
- Depending on the building conditions, additional irrigation should be an option.
- The level of maintenance required depends on the pitch of the roof and the vegetation used.

Enduring Success with Pitched Green Roofs – What Do we Need to Know?

When is a Green Roof Pitched?

While even flat roofs should have a pitch of at least 2 % for the purposes of this brochure a pitched roof is one with a pitch of at least 10°, which is just under 18 %.

Upwards of this pitch, the green roof build-ups differ from those that are used for flat roofs and low-pitched roofs.

On one hand, the shear forces from the green roof build-up increases the steeper the roof pitch is and needs to be diverted to a sufficiently stable counter support. On the other hand, the substrate layer also has to be protected from erosion. The choice of plants and their application must be compatible with the roof pitch and the level of exposure.

Additional Irrigation

Additional irrigation during dry periods guarantees an impressive appearance and extends the flowering season. Irrigation can be provided either by means of drip lines installed along the roof ridge or “over head” by means of a sprinkler or spray nozzle.

A Root-Resistant Waterproofing is a Requirement

A professionally sealed roof area, e.g. with bitumen or a synthetic membrane, is required for a green roof to function permanently. The waterproofing membrane should be root-resistant, as it is very difficult to install additional root-resistant sheets on pitched roofs.

It is important that the issue of the maintenance of the green roof is addressed right from the beginning. Skylights can be used to access the roof area. A sufficient number of anchor points should be planned for around the roof area, to which people can anchor themselves when carrying out maintenance and service works on the roof.



In the case of roof penetrations it is important to ensure that the waterproofing layer is drawn up to at least 100 mm above the upper edge of the substrate layer. Green roof build-ups can be bordered using the stainless steel Eaves Profile TRP 140 in combination with shear retainers (either Support Bracket TSH or Shear-Fix LF).



The use of solar energy is also possible on pitched green roofs. The issue as to how each system can be installed without penetrating the waterproofing for example by using the ZinCo Solar Base®, is addressed for each individual system.



This roof with a pitch of approx. 5° is drained using a gutter and does not yet require any special measures.



A shear barrier is placed just above the eaves on this monopitch roof, which is drained by means of an outer-lying gutter.



With this roof, which has a pitch of approx. 30°, a shear barrier was installed within the roof area, in addition to the stable eaves upstand.



When dimensioning an eaves upstand or shear barrier, the decisive factor is not only the water-saturated weight of the green roof build up but also the estimated snow loads for the locality.

Roof pitch: Degrees	10°	15°	20°	25°	30°	35°	40°	45°
Per cent	15%	30%	45%	60%	80%	100%		
System Build-up for "Flat Roofs" (see Planning Guide "Extensive Green Roofs")	System Build-up for "Flat Roofs" (see Planning Guide "Extensive Green Roofs")		System Build-up for "Pitched Green Roofs" (see page 6)		System Build-up for "Steep Pitched Green Roofs" (see page 10)		Special solutions in consultation with ZinCo Technical Department	

Shear Forces

The diagram on the right indicates which measures are generally required for which roof pitch.

It is also important to check if, in the case of the roof sub-structure, measures have to be undertaken to prevent the roof layer package from slipping down. This may already be useful for a roof pitch of less than 10°.

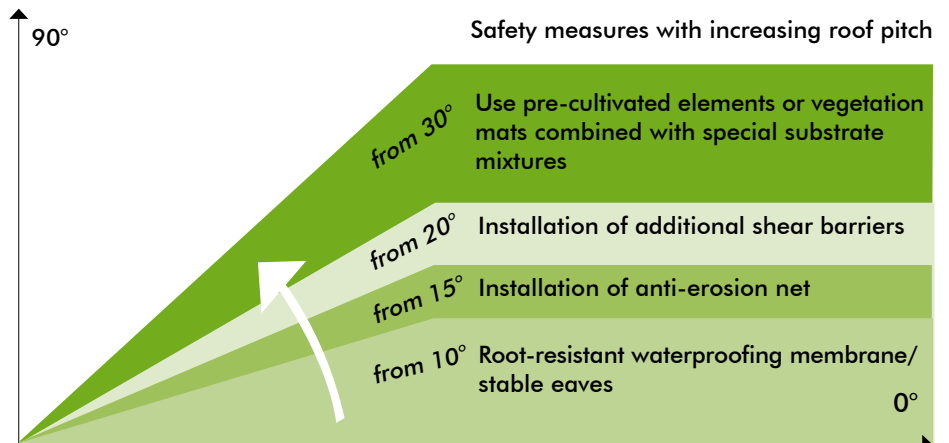

Pitched Green Roof with Floraset® FS 75



- Tried and proven across thousands of square metres – a low-maintenance green roof build-up for root-resistant waterproofed roofs with a pitch of between approx. 10° and 25°.
- The Floraset® FS 75 elements installed across the entire roof surface interlock well with the substrate and prevent it from sliding off.
- These elements distribute the shear forces safely into the eaves upstand that has been dimensioned in line with structural requirements or into additional shear barriers.
- Additional anti-erosion protection thanks to the coarse-meshed Jute Anti-Erosion Net JEG for roof pitches > 15° or in the case of exposure to strong winds.
- The build-up can withstand sparks and radiant heat and is classified as a “hard roof” in compliance with the German standard DIN 4102, Part 7.



This private home in Korb, Germany was covered in 1987 with the ZinCo System Build up “Pitched Green Roof” using perennials. The roof pitch is just under 25°. Without additional irrigation and with maintenance carried out only once or twice a year, the character of the vegetation has hardly changed. Of course, a few types of plants have disappeared over the years and some have been brought there by birds or wind. The vegetation has always formed a closed coverage and erosion did not occur. The green roof and the root-resistant waterproofing membrane are still functional. This wooden house with its green roof is a really attractive eye-catcher.



Weight kg/m ²		Depth mm
dry	saturated	
75	105	
2	10	
77	115	

Depth mm

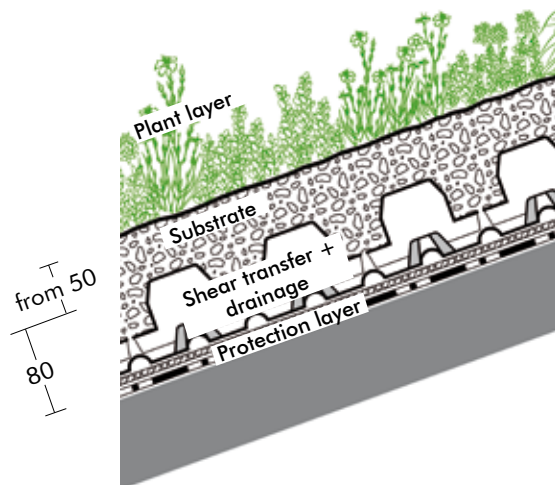

Plug plants as per plant list "Pitched/ Steep Pitched Green Roof"

System Substrate "Rockery Type Plants"

Floraset® FS 75

Protection Mat BSM 64

A root-resistant waterproofing membrane is required.

Roof pitch:		10-15°	15-20°	20-25°	
Build-up height:	ca.	130	140	150	mm
Weight, saturated:	ca.	115	130	145	kg/m ²
Water storage capacity:	ca.	38	40	44	l/m ²

Technically Sound Detail Solutions for Enduring Success with Your Pitched Roof

Roof Perimeter with Drainage into Outer-Lying Gutter

Very often with pitched green roofs, an outer-lying gutter is the drainage option of choice. With this option, the shear force created by the green roof build-up has to be transferred to the roof structure via an eaves profile with drainage slots and an eaves support bracket. This allows for excess rain water to drain away unobstructed.

Support brackets and steel angles must be arranged in line with structural requirements. We recommend a loose-fixed flange construction for securing the eaves support bracket.

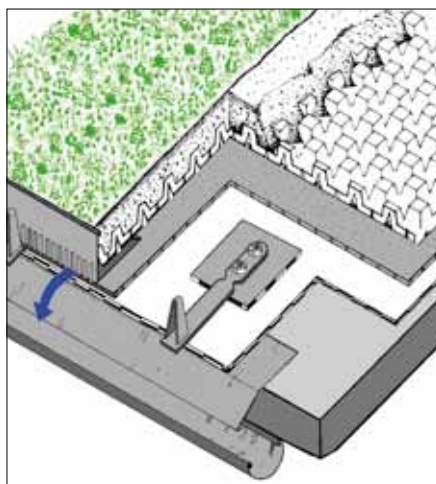

Eaves Profile
TRP 140

Support Bracket
TSH 100

Shear Fix LF 300



In conjunction with a ZinCo Eaves Profile, this stable stainless steel bracket replaces a shear barrier made of wood-based products.

On pitched roofs the Shear Fix LF 300 is used at the eaves together with the Eaves Profile TRP 80 or TRP 140 to prevent the green roof build-up from slipping, or as a shear barrier within the roof area. It is mounted onto the support structure using 5 pcs. corrosion-resistant screws and is sealed in line with the loose-fixed flange system as per German standard DIN 18195-9 with the waterproofing materials used for the building.

Additional Shear Barriers

As the system substrate interlocks well with the Floraset® elements, shear forces occurring with roof pitches of up to approx. 20° can usually be distributed to the eaves upstand.

However, where the roof pitch is greater and/or the roof is longer, additional shear barriers must be installed. Up to now, wooden shear barriers were generally used here. They were anchored to the roof sub-structure and sealed separately.

Given the loose-fixed flange construction, the same detail can be used as with the eaves. This achieves a vegetation which is visually not interrupted.

The shear force taken up by the eaves upstand or the shear barrier depends on the build-up weight (incl. snow load), the

pitch of the roof ($\sin \alpha$), the shear length and the coarseness of the waterproofing layer. For safety reasons, the latter should not be taken into account.

In our experience, if there are no project specific calculations, the following shear barrier distances should not be exceeded:*)

System Build-up "Pitched Roof":

20° pitch: approx. 10 m

System Build-up "Steep Pitched Roof":

25° pitch: approx. 8 m

*) These distances must be reduced in the case of snow loads above 75 kg/m². Please consult a structural engineer!

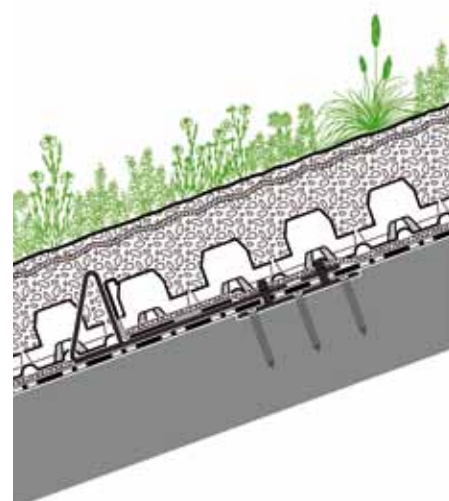

With the Loose-fixed flange construction of the Shear Fix LF 300 and the Eaves Profile TRP 80 even shear barriers within the green roof area can be realised.





Eaves with Water Spouts and Eaves Throughs

A pitched green roof can be built like a “tilted” flat roof. But to do this, the upstand around the eaves must be sufficiently high and stable.

Excess rainwater can be drawn off by water spouts into the gutter and the attached downpipes. The channel system of the Floraset® elements provides for the necessary lateral distribution of the water. Additional drainage pipes are not required.

In principle, drainage is possible using roof outlets. However, they have to be positioned directly in front of the eaves upstand. A clearance of 300 mm, as is generally specified in the German Flat Roof Guidelines for roof penetrations etc. is not best practice here.

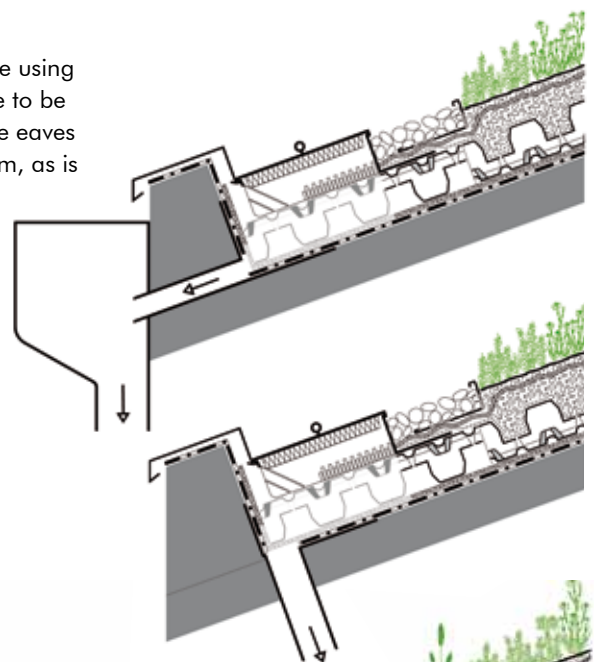

“Thinner” Roof Edge Desired

For reasons of visual appearance – in particular with monopitch roofs – great importance is attached to a “thin” roof edge. This is achieved by moving the Eaves Support Bracket back from the edge and not greening the front part of the roof. However, it is important to ensure in this case that the waterproofing membrane is protected or that a suitable weather-resistant waterproof membrane is applied.

Stainless Steel Profile secured with an Support Bracket

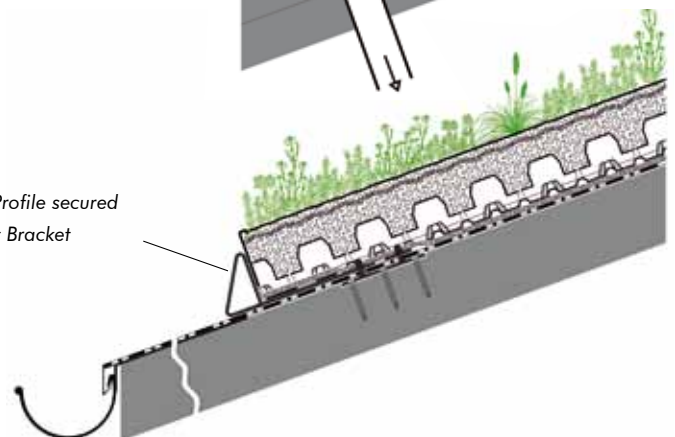

Steep Pitched Green Roof with ZinCo Georaster®



The System Build-up “Steep Pitched Green Roof” based on the ZinCo Georaster® system, as presented here, is suitable for greening roof areas with a pitch of over 25°. The Georaster® elements are 540 x 540 mm in size, 100 mm high and made of recycled polyethylene (HDPE). No tools are required to attach them to each other. The result is a stable and continuous unit.

An area on which these grid elements have been installed is safe to walk on and can be filled with system substrate.

Thanks to the low volume of the Georaster® elements themselves, a relatively large space remains for root development. The choice of plants must, of course, be suited to the extreme location of a steep pitched roof, where exposure to the sun can be extreme and rainwater flows off quicker than on a flat roof.

In order to avoid gaps in the vegetation that could also be the start of erosion, irrigation should be considered as an option, even though it may only be needed in critical times. With the System Build-up

“Steep Pitched Green Roof” it is important to ensure that any occurring shear forces can be diverted to stable eaves upstands and, if necessary, additional shear barriers.

In addition to their use on pitched roofs, Georaster® elements can also be used as a reinforcement for gravel lawns, for creating pathways, when securing embankments etc.

Steps to Creating a Steep Pitched Green Roof:



The roof area to be greened is sealed with rolls of waterproofing membrane that have been tested for their root-resistance in line with FLL procedures.



Once the area has been covered with the Protection Mat WSM 150, the Georaster® elements are installed, starting from the bottom up.



The system substrate “Heather with Lavender-light” is, e.g. delivered in a silo tanker. It is then blown onto the roof using a hose until the Georaster® elements are filled and covered up to about 10 mm over their upper edge.



Weight kg/m ²		Depth mm
dry	saturated	
89	155	120

Depth
mm

120

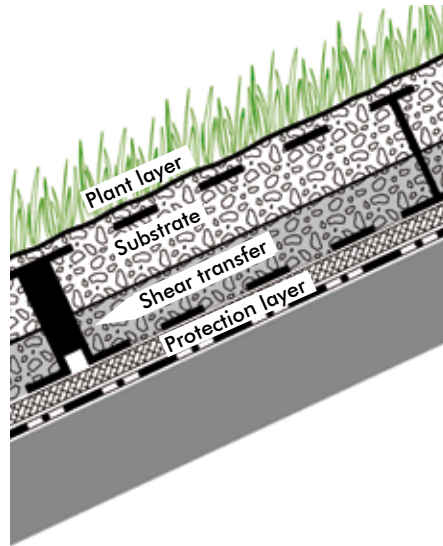

Dense planting in line with the plant list "Pitched/Steep Pitched Green Roof"*)

Filled with system substrate "Heather with Lavender-light" (up to approx. 10 mm over the top of the Georaster® elements)

Georaster® elements

Protection Mat WSM 150

A root-resistant waterproofing membrane is required.

Build-up height: from 120 mm
 Weight, saturated : from 155 kg/m²
 Water storage capacity: from 64 l/m²



Finally, the roof is densely planted with various Sedum species and other perennials.



Even after only one vegetation period the plant coverage is largely complete. The roof area in this example is drained by means of an outer-lying gutter into which the three water spouts carry any excess water.

Georaster® element

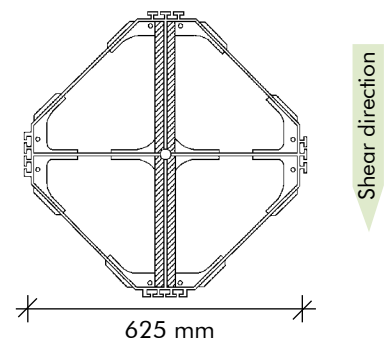

*) Georaster® elements are generally planted with at least 28 plug plants per m². Therefore, there are at least 2 plants in each field of the element. Additional perennials for visual highlights as per the plant list "Pitched/Steep Pitched Green Roof" are possible. We recommend using vegetation mats or EcoSedum® elements for roofs of approx. 30° and upwards.

Green Roof Solutions for Pitched Roofs of a Different Kind

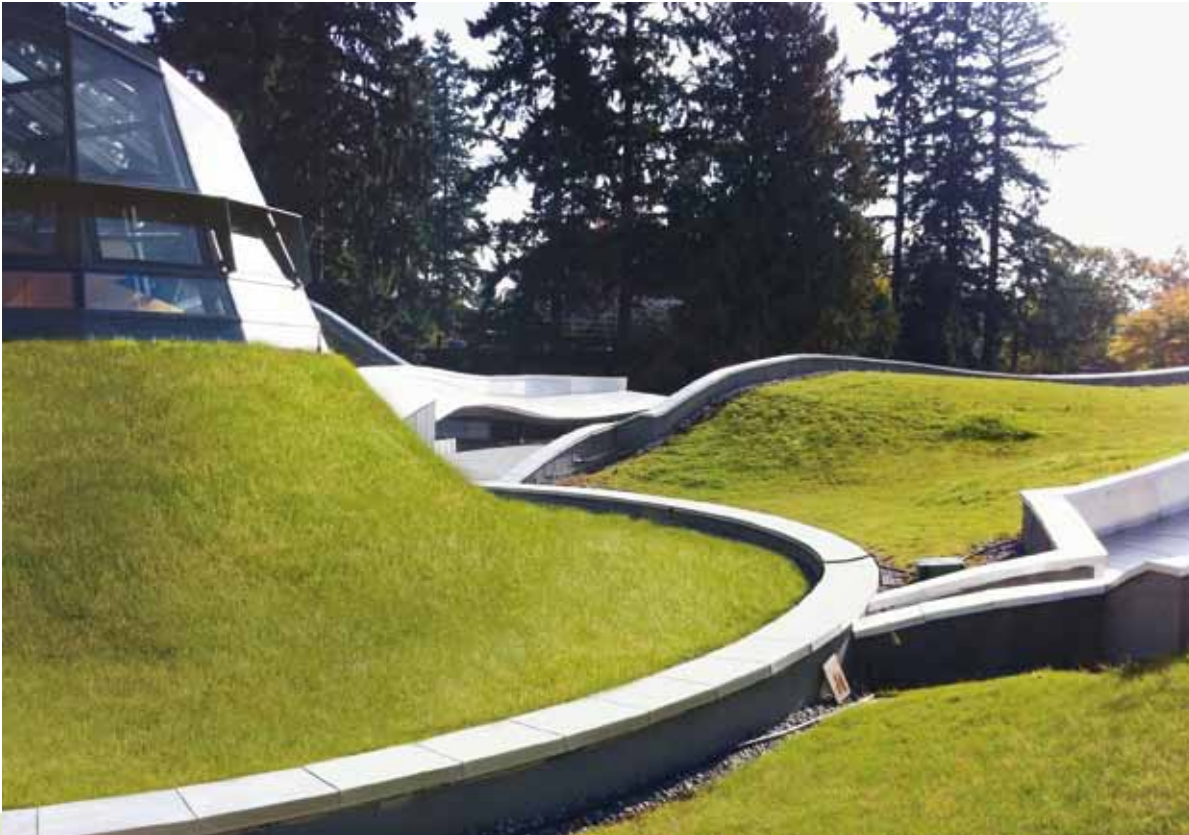

The curved shapes of an orchid native to British Columbia served as the template for the green roofs on the visitor centre at the Van Dusen Botanical Gardens in Vancouver, Canada. Grouped around the roof of the central atrium, which is designed as a truncated cone, and which also represents the pistil of the orchid, are other roof areas that resemble petals.

This concept was realised using a combination of the System Build-ups "Steep Pitched Green Roof" and „Pitched Green Roof“.

This was achieved by dividing those areas of the truncated cone with a pitch of up to 45° into segments with rings

formed by load-distribution shear barriers. Once the Protection Mats WSM 150 were laid, the Georaster® elements were installed.

The System Build-up "Pitched Green Roof" with Floraset® FS 75 was used for the roof areas of the petals, which have a pitch of between 5 and 25°. With a build-upweight of up to 215 kg/m² and an estimated snow load of up to 190 kg/m², shear barriers were also required on these roofs at a distance to each other of between 5 and 9 m, depending on the pitch.



Perfect Accessories for Steep Pitched Green Roofs

Snow guards are a tried and proven means of warding off the danger presented by sliding snow on pitched and steep pitched roofs. ZinCo offers an effective solution that does not require tools to install it based on the Georaster® elements. Thus penetrations of the waterproofing membrane are avoided. The snow guard is mounted on brackets attached to the Georaster® elements. The dimensions of a snow guard must be calculated separately for each individual building.



The system is rounded off with the steep pitched roof inspection chamber, which can be installed above the run-off in the case of internal water outlet.

Intensive Green Roof on Pitched Roofs – It's possible with System Technology

When the building complex "Australia Building" in Amsterdam, the Netherlands, was being renovated, included in the brief was the overhaul with a contemporary look of what was up to then a dreary courtyard and the warehouse beneath it. This was to include a 550 m² green area with "portholes" protruding from the steep pitched areas.

These portholes provide daylight for the rooms below. Achieving a homogenous transition from the flat to the steep section was challenging from a green roofing point of view. On the flat part, the System Build-up "Roof Garden" with a substrate depth of approx. 0,2 m was used. In order to apply the required shear-protected and

therefore enduring substrate depth to the 40° steep pitched areas, Georaster® elements were installed in two staggered layers. Elastodrain® Strips were used as a base to protect the waterproofing membrane in the eaves area. Since completion, an irrigation system provides for the luscious greenery.



Holistic Use of a Building Implemented Systematically

The gymnasium at the Clara-Grunwald School, designed by architect Lorenz Wehrle (Freiburg/Germany) was completed in the summer of 2006. The concept outlined by the Freiburg building authority stated that the entire roof of the gymnasium was to be a publically-accessible green area. Even sledging down in winter was a requirement. For this reason, a strong pressure-resistant thermal insulation layer of foam glass was used for the roof build-up. Over the double layer bitumen roof waterproofing Floratherm® elements, type WD 65-H, were installed across the entire surface.



The transition area was covered with gravel and topsoil, in order to connect the roof with the natural ground underneath.



Once the Floratherm® elements were installed approx. 0,15 m of intensive substrate was blown onto the area.



Due to the subsequent intended use, a durable landscape lawn was used which of course has to be mowed regularly.



Roof Design with a Difference: Even Material Variations have their own Charm



Unusual, but certainly with charm. A tiled/green roof on a private residence in Sipplingen, Germany.



This semi-detached house near Tübingen, Germany, provides a contrast between different types of design. Wooden and rendered facade, tiled and green roof.



Sometimes it is a matter of structural design, as can be seen here (extreme pitch in the lower roof area), that leads to two different "coverings" being used on the same building.

Green Roof on Barrel Roofs – the Basics

If there is a stable eaves upstand available, the System Build-up "Pitched Green Roof" can also be used for barrel roofs. If the roof area is extremely curved, the Floraset® elements should perhaps be divided in the middle, as was done with the former fortress "Lunette" in Rastatt, Germany.



There is no standard solution for barrel roofs. However, solutions specific to your building can be worked out in conjunction with the ZinCo Technical Department, as seen with the roofs of apartment blocks in Pfäffikon in Switzerland (photo above). As gravel edge strips cannot be used for roofs with an extreme pitch, grass pavers ensure a solid and location-stable option for eaves drainage.

In the picture on the right, the System Build-up "Steep Pitched Roof" with Georaster® elements is installed in the steep, lower area. The elements distribute the shear forces into smaller portions and

help to keep the erosion stretches very short. The transition to the System Build-up "Pitched Roof" in the upper area with a lower pitch is possible thanks to the Eaves Profile held against it. The drainage element Floraset® FS 75 interlocks well with the substrate.



Particularly Significant for Pitched Green Roofs: the Correct Choice of Plants

In order to prevent erosion, the vegetation layer on a pitched roof should be permanently covered. As these roof areas are generally visible, a pitched green roof should of course be visually very appealing. However, a pitched roof is different in many ways to a flat roof: water runs off more quickly and is not as easy to retain. In the case of a steep pitch and an orientation to the sun, these differences are particularly accentuated. For structural reasons it is often not possible to increase the depth of the substrate. Without additional irrigation, therefore, the choice of plants is considerably limited.



The type of vegetation that will survive on pitched roofs without additional irrigation can be seen in the three photos from the Gardening Department of the City of Tübingen, Germany (System Build-up "Pitched Green Roof" carried out in 1986). The turf rolls installed initially on the north-facing side failed entirely after a short space of time, while the Sedum-herb vegetation on the south-facing side (plant community "Rockery Type Plants") also took over the north-facing side.

Grass on the Roof

As mentioned previously, a lawn can be established permanently on pitched roofs. However, it is important to take into consideration that the lawn has to be mowed regularly and that the cut grass has to be brought down from the roof. With a low build-up depth, the water supply must be ensured by means of a perfectly functioning irrigation system.



An alternative to a conventional lawn is drought-resistant grass vegetation such as the plant community "Grassy Pasture" or "Country Colours". The result is a roof with "wild meadow character" in which a variety of species will be maintained when mowed once a year.



Recommended Plants for Pitched Green Roofs

Ground cover perennials	Recommended proportion
<i>Sedum album</i> in varieties	approx. 0 - 10 %
<i>Sedum floriferum</i> 'Weihenstephaner Gold'	approx. 30 - 40 %
<i>Sedum hybridum</i> 'Immergrünchen'	approx. 15 - 20 %
<i>Sedum kantschaticum</i>	approx. 15 - 20 %
<i>Sedum spurium</i> 'Pink' and 'White'	approx. 15 - 20 %
Small group perennials	
Plant list "Pitched/Steep Pitched Green Roof"	in addition to the above 4 - 5 pcs/m ²
Plant density (incl. small group perennials)	up to 15°: at least 20 pcs/m ² up to 20°: at least 24 pcs/m ² up to 25°: at least 28 pcs/m ² up to 30°: at least 34 pcs/m ²

Choice of Plants

Plug plants from the plant community "Pitched/Steep Pitched Green Roof" can be used on pitched roofs. Sedum is generally the main type of vegetation used while the other perennials on a pitch of approx. 20° offer additional flowering, above all in the shady and less exposed areas. Generally speaking, they should only be used occasionally in groups of 3 or 5 (or maximum 7). Upwards of a pitch of 25°, the perennial "proportion" should be reduced, as Sedum is more capable of thriving with a low water supply and ensuring protection against erosion.

It is best to use only Sedum for green roofs with a pitch of 30° and upwards. It is worth noting that the individual space for a Sedum species should generally be limited to 1 - 2 m². The above-mentioned

Sedum species will provide for stable vegetation with good ground coverage if the recommended proportions are adhered to.

For Special Applications: ZinCo EcoSedum®



Roof pitch over 30°: Pre-cultivated Sedum Vegetation Mats or EcoSedum® elements should be used for this and greater roof pitches and in exposed ridge or roof edge areas.

Solutions for a **roof pitch over 35°** and building-specific plant recommendations are available from our ZinCo Technical Department.

System Technology Provides for a Permanent and Perfect Green Roof!

This Planning Guide aims to answer any queries you may have about pitched green roofs.

Our engineers will be glad to help you work out the details for your own particular project; from the planning stage right through to creating the required specification texts.



ZinCo GmbH · Lise-Meitner-Strasse 2 · 72622 Nuertingen · Germany
Phone: +49 7022 6003-0 · Fax: +49 7022 6003-100
info@zinco-greenroof.com · www.zinco-greenroof.com